

J'achète ceci :

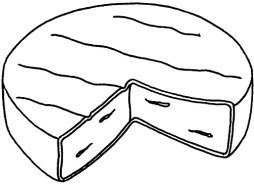
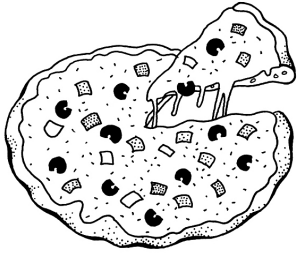

	<p>1 euro</p>
	<p>2 euros</p>
	<p>7 euros</p>

Combien dois-je donner d'argent à la caissière ?

<p>Prix du lait</p>	<p>+</p>	<p>Prix du camembert</p>	<p>+</p>	<p>Prix de la pizza</p>	<p>=</p>	<p>Je dois donner à la caissière.</p>
	<p>+</p>		<p>+</p>		<p>=</p>	

Je dois donner euros à la caissière.

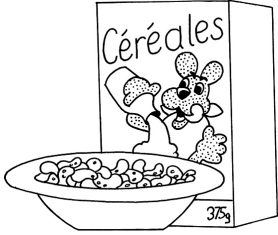
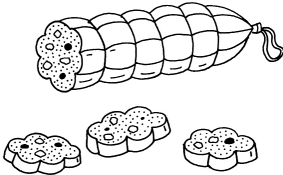
J'achète ceci :

	<p>4 euros</p>
	<p>5 euros</p>
	<p>3 euros</p>

Combien dois-je donner d'argent à la caissière ?

<p>Prix du paquet de céréales</p>	<p>+</p>	<p>Prix du saucisson</p>	<p>+</p>	<p>Prix du jus d'orange</p>	<p>=</p>	<p>Je dois donner à la caissière.</p>
	<p>+</p>		<p>+</p>		<p>=</p>	

Je dois donner euros à la caissière.

J'achète ceci :

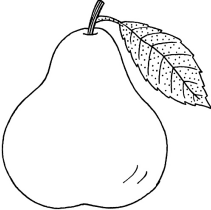
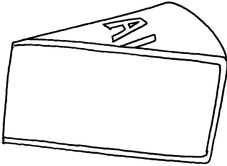
	<p>2 euros</p>
	<p>3 euros</p>
	<p>5 euros</p>

Combien dois-je donner d'argent à la caissière ?

<p>Prix d'un litre d'huile</p>	<p>+</p>	<p>Prix d'un kilo de poire</p>	<p>+</p>	<p>Prix d'un morceau de fromage</p>	<p>=</p>	<p>Je dois donner à la caissière.</p>
	<p>+</p>		<p>+</p>		<p>=</p>	

Je dois donner euros à la caissière.

J'achète ceci :

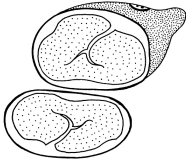
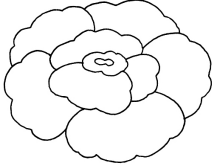
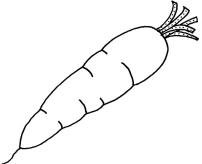

	5 euros
	1 euro
	3 euros

Combien dois-je donner d'argent à la caissière ?

Prix de 3 tranches de jambon	+	Prix d'une salade	+	Prix d'un kilo de carottes	=	Je dois donner à la caissière.
	+		+		=	

Je dois donner euros à la caissière.

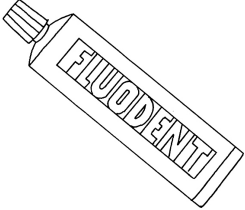
J'achète ceci :

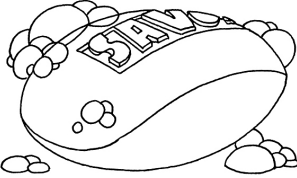
	2 euros
	3 euros
	1 euro

Combien dois-je donner d'argent à la caissière ?

Prix d'un tube de dentifrice	+	Prix d'une brosse à dents	+	Prix d'un savon	=	Je dois donner à la caissière.
	+		+		=	

Je dois donner euros à la caissière pour acheter tout ça.

J'achète ceci :

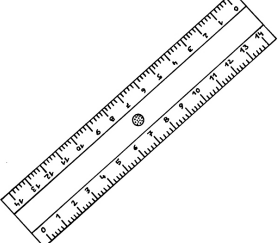
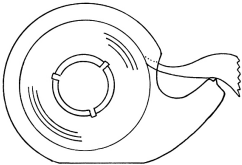
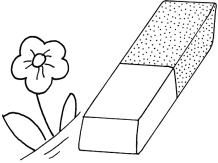
	<p>2 euros</p>
	<p>2 euros</p>
	<p>2 euros</p>

Combien dois-je donner d'argent à la caissière ?

<p>Prix d'une règle</p>	<p>+</p>	<p>Prix d'un rouleau de scotch</p>	<p>+</p>	<p>Prix d'une gomme</p>	<p>=</p>	<p>Je dois donner à la caissière.</p>
	<p>+</p>		<p>+</p>		<p>=</p>	

Je dois donner euros à la caissière.

J'achète ceci :

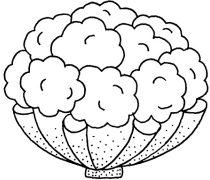
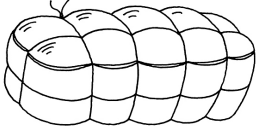
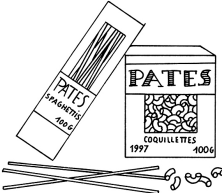

	<p>1 euro</p>
	<p>8 euros</p>
	<p>3 euros</p>

Combien dois-je donner d'argent à la caissière ?

<p>Prix d'un chou fleur</p>	<p>+</p>	<p>Prix d'un rôti</p>	<p>+</p>	<p>Prix d'un paquet de pâte</p>	<p>=</p>	<p>Je dois donner à la caissière.</p>
	<p>+</p>		<p>+</p>		<p>=</p>	

Je dois donner euros à la caissière.

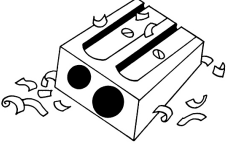
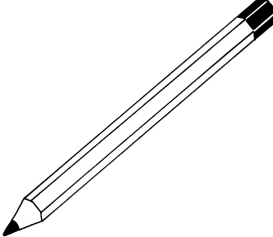
J'achète ceci :

	<p>2 euros</p>
	<p>1 euro</p>
	<p>2 euros</p>

Combien dois-je donner d'argent à la caissière ?

<p>Prix d'un taille crayon</p>	<p>+</p>	<p>Prix d'un crayon</p>	<p>+</p>	<p>Prix d'un cahier</p>	<p>=</p>	<p>Je dois donner à la caissière.</p>
	<p>+</p>		<p>+</p>		<p>=</p>	

Je dois donner euros à la caissière.

J'achète ceci :

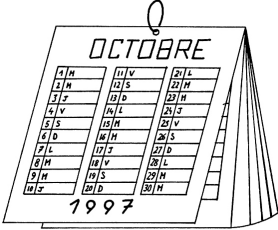
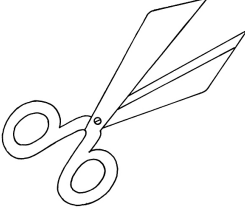

	<p>4 euros</p>
	<p>5 euros</p>
	<p>2 euros</p>

Combien dois-je donner d'argent à la caissière ?

<p>Prix d'une trousse</p>	<p>+</p>	<p>Prix d'un calendrier</p>	<p>+</p>	<p>Prix d'une paire de ciseaux</p>	<p>=</p>	<p>Je dois donner à la caissière.</p>
	<p>+</p>		<p>+</p>		<p>=</p>	

Je dois donner euros à la caissière.

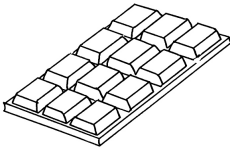
J'achète ceci :

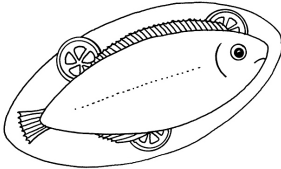
	<p>2 euros</p>
	<p>3 euros</p>
	<p>7 euros</p>

Combien dois-je donner d'argent à la caissière ?

<p>Prix d'une plaque de chocolat</p>	<p>+</p>	<p>Prix d'un paquet de riz</p>	<p>+</p>	<p>Prix d'un poisson</p>	<p>=</p>	<p>Je dois donner à la caissière.</p>
	<p>+</p>		<p>+</p>		<p>=</p>	

Je dois donner euros à la caissière.